

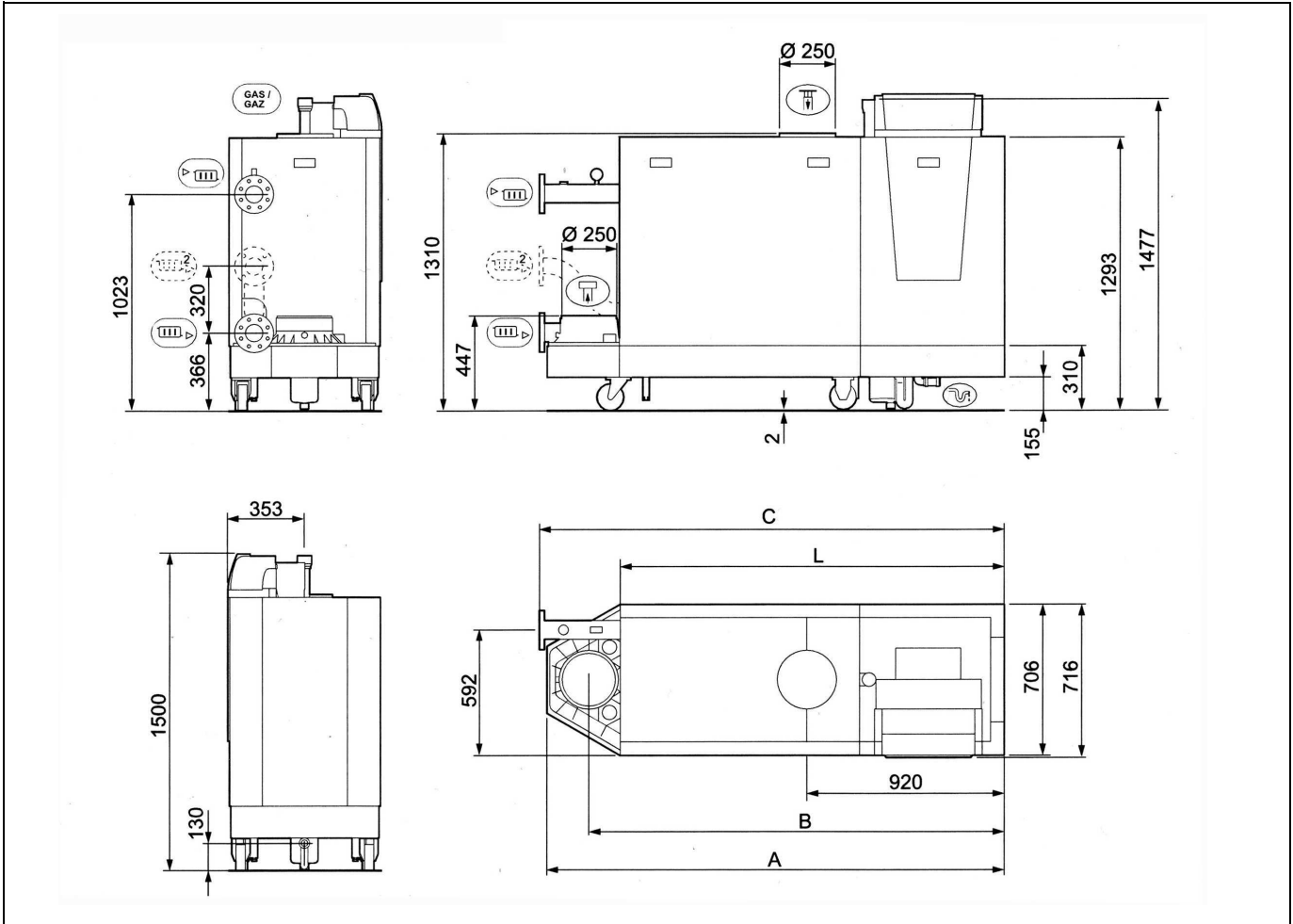







Abmessungen

GiegaBloc 510



	Vorlauf:	NW 80, DIN 2576 - PN 10
	Rücklauf :	NW 80, DIN 2576 - PN 10
	Gasanschluss:	G 2"
	Kondenswasserabfluss:	$\varnothing 32$ mm innen
	Verbrennungsluftzuführung:	$\varnothing 250$ mm
	Abgasabführung	$\varnothing 250$ mm
	Zweiter Rücklauf (optional):	NW 65, DIN 2576 - PN 10

GiegaBloc	A	B	C	L
510-5	1833	1635	1862	1490
510-6	1833	1635	1862	1490
510-7	1833	1635	1862	1490
510-8	2142	1944	2172	1800
510-9	2142	1944	2172	1800
510-10	2142	1944	2172	1800